

On 3-choosability of plane graphs without 6-, 7- and 8-cycles

Bernard Lidický*

Abstract

A graph is k -choosable if it can be colored whenever every vertex has a list of available colors of size at least k . It is a generalization of graph coloring where all vertices do not have same available colors. We show that every triangle-free plane graph without 6-, 7-, and 8-cycles is 3-choosable.

1 Introduction

List coloring is a generalization of graph coloring where every vertex v has its own list of colors $L(v)$. The coloring c assigns every vertex v a color from $L(v)$. Moreover colors of vertices joined by an edge must be different. The concept of the list coloring was introduced independently by Vizing [7] and Erdős, Rubin and Taylor [2].

We say that a graph G is k -choosable if it allows a list coloring for every list assignment such that $|L(v)| \geq k$ for every vertex v . Observe that the graph coloring problem is a special case of the list coloring problem where all lists have the same content.

Thomassen [5] proved that every planar graph is 5-choosable. Voigt [8] showed that not every planar is 4-choosable. Kratochvíl and Tuza [3] showed that every planar triangle-free graph is 4-choosable, and Voigt [9] exhibited an example of a non-3-choosable triangle-free planar graph.

There are several sufficient known conditions for 3-choosability of planar triangle-free graphs. Alon and Tarsi [1] proved that every planar bipartite

*Department of Applied Mathematics, Faculty of Mathematics and Physics, Charles University, Malostranské náměstí 25, 118 00 Prague 1, Czech Republic. E-mail: bernard@kam.mff.cuni.cz.

graph is 3-choosable. Thomassen [6] gave a proof showing that every planar graph without 3-, and 4-cycles is 3-choosable. Lam, Shui and Song [4] proved that every planar graph without 3-, 5- and 6-cycles is 3-choosable. Zhang and Xu [11] proved that every planar graph without 3-, 6-, 7- and 9-cycles is 3-choosable. Zhang [10] proved that every planar graph without 3-, 5-, 8- and 9-cycles is 3-choosable.

We show that every planar graph without 3-, 6-, 7- and 8-cycles is 3-choosable. We also show another proof for 3-choosability of planar graphs without 3-, 5- and 6-cycles as a corollary.

Note that the latest results are proved using discharging and the forbidden cycles arise from forbidden configurations of smaller cycles.

The idea of discharging is to take the smallest counterexample, identify some configurations which cannot occur in the smallest counterexample, and finally by counting to get that the counterexample does not satisfy the Euler's formula for planar graphs.

2 Reducible configurations

A *configuration* R is (H, d) where H is a simple graph and d is a function $V(H) \rightarrow \mathbb{N}$. Graph G contains R if G contains a subgraph K such that there is an isomorphism $f : H \rightarrow K$ and for every vertex v from $V(H)$ holds that $\deg_G(f(v)) = d(v)$.

We say that a configuration R is *reducible* if removing R from any graph G does not affect the property of 3-choosability of G .

Note that removing any configuration R from a 3-choosable graph G does not make G non-3-choosable since we only delete edges and vertices. On the other hand removing R from a non-3-choosable graph G can turn G into a 3-choosable graph but this is not the case for reducible R .

Observe that an isolated vertex v and a function $d(v) = 1$ or $d(v) = 2$ is a reducible configuration since adding a vertex of degree 1 or 2 to a graph G does not turn G into a non-3-choosable graph.

Next we describe a bigger reducible configuration. Let $Z = \{C_4^1, C_4^2, \dots, C_4^n\}$ be a connected graph which is created as a union of 4-cycles such that two 4-cycles are allowed to share at most one vertex and one vertex can be contained in at most two 4-cycles. Moreover $C_4^1, C_4^2, \dots, C_4^n$ are the only cycles in Z . Observe that the 4-cycles must form some kind of a tree structure. Refer to the black drawing in Figure 1.

We create H from Z by adding some edges joining vertices of degree two

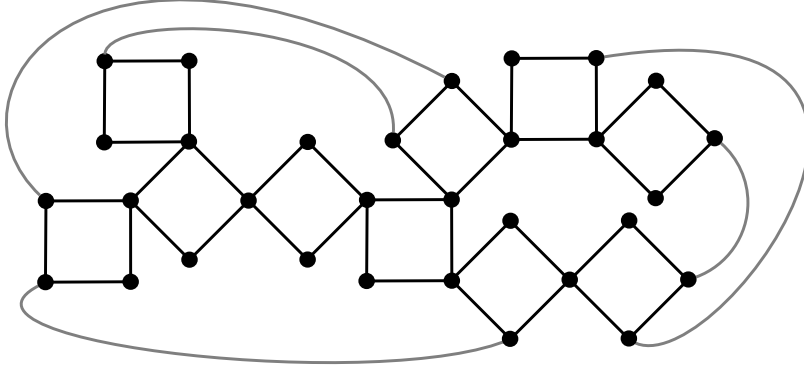

Figure 1: C_4 -arbor

in distance more than two. Moreover every vertex can be in at most one added edge. We call such graph H C_4 -arbor. We show that H with suitable d is a reducible configuration. Note that we do not require C_4 -arbors to be planar but we need only planar C_4 -arbors. Refer to Figure 1 for an example of planar C_4 -arbor.

Lemma 1. *Let H be a C_4 -arbor and $d : V(H) \rightarrow N$ defined as follows.*

$$d(v) = \begin{cases} \deg_H(v) & \text{if } \deg_H(v) \geq 3 \\ 3 & \text{if } \deg_H(v) = 2 \end{cases}$$

Then $R = (H, d)$ is a reducible configuration.

Proof. Let G be a graph and H is a C_4 -arbor subgraph with degrees according to d . Assume that $G \setminus H$ is 3-choosable. Our goal is to show that G is also 3-choosable. More precisely we want to extend a list coloring c of $G \setminus H$ to a list coloring c' of G . We assume that every vertex v of still uncolored H has $L(v)$ of size 3.

The proof proceeds by induction on n . Let H be formed by a union of 4-cycles $Z = \{C_4^1, C_4^2, \dots, C_4^n\}$ and some additional edges. Observe that every vertex v in H with $\deg_H(v) = 2$ has $\deg_G(v) = 3$ and the other vertices of H have the same degree in G as in H . Since v of $\deg_H(v) = 2$ has exactly one neighbor u in $G \setminus H$, it has a forbidden color $c(u)$. We alter $L(v)$ to $L(v) \setminus \{c(u)\}$ to avoid conflict during extending c .

$$|L(v)| = \begin{cases} 2 & \text{if } \deg_H(v) = 2 \\ 3 & \text{otherwise} \end{cases}$$

First we consider case $Z = \{C_4^1\}$ for starting the induction. Then $H = F$ since we are not allowed to add any new edge and $d(v) = 2$ for every vertex v from $V(H)$.

The discussion why C_4 can be colored is analogous to the discussion for the induction step or we could use the fact that C_4 is 2-choosable.

If all 4-cycles have at least two shared vertices, then we can find a long cycle which is forbidden by the definition of C_4 -arbor. Thus there is a 4-cycle C with exactly one shared vertex x .

We color the non-shared vertices u, v, w of C such that there will remain two possible colors for x . Then we remove u, v and w from H . This decreases the number of 4-cycles and the shared vertex x becomes a vertex of degree 2 with $L(x)$ of size 2. Hence we can use the induction.

Let the shared vertex x be adjacent to u and v ; refer to Figure 2. We distinguish two cases.

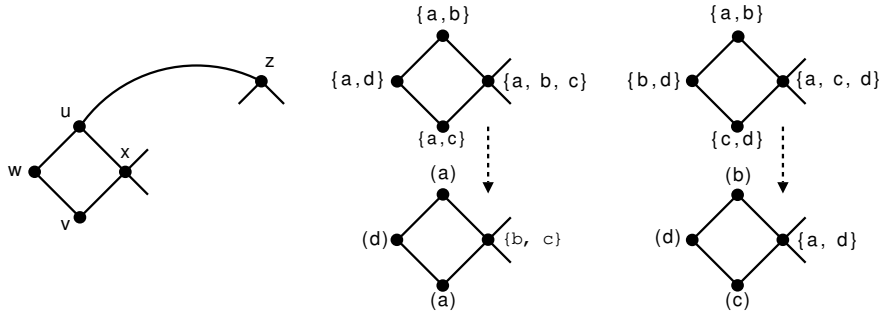

Figure 2: The 4-face in the induction step.

If a is a common color of $L(u)$ and $L(v)$ then we color u and v by a . Since u and v have the same color a , there are still at least two colors left in $L(x)$ and at least one color is left in $L(w)$. Thus we can assign a color to w and preserve a color list of size 2 for x .

In the other case the color lists of u and v are disjoint. Their color lists have 4 different colors together while $L(x)$ contains only 3 colors. Hence

there is a color b which is not in $L(x)$. Without loss of generality assume that b is in $L(u)$. We color u by the color b . Then we color w by a color distinct from b . Finally we color v by a color different from the color of w . The color of v may be present in the color list of x , but there are still at least 2 different colors left in the color list of x .

We also need to deal with vertices of H joined to vertices u , v , and w by edges, if there are any. Let z be a vertex connected to vertex u . The vertex z has a color list of size 3. So we can remove the color of u from the color list of z to avoid conflict. The vertex z is then treated as a vertex of degree two. \square

3 Initial charges

In this section we show the initial charges for faces and vertices. We start with defining that for a plane graph G the *degree of a face f* is number of incident edge sides. We denote it by $\deg(f)$. Observe that one edge can raise the degree of a face by two if both sides of the edge are incident with the face.

Recall that that for every plane graph G holds that $\sum_{v \in V} \deg(v) = 2|E|$ and observe that also holds that $\sum_{f \in F} \deg(f) = 2|E|$ since every edge is counted twice.

The *initial charge of a face f* is defined by $ch(f) = \deg(f) - 6$ and the *initial charge of a vertex v* is defined by $ch(v) = 2 \deg(v) - 6$. Refer to Table 1 for initial charges for small degrees.

deg	$ch(f)$	$ch(v)$
3	-3	0
4	-2	2
5	-1	4
6	0	6
7	1	8

Table 1: Initial charges of face f and vertex v depending on their degree.

Lemma 2. *If G is a plane connected graph, then the sum of all initial charges is negative.*

Proof. The idea of the proof is based on counting with Euler's formula. Let $G = (V, E)$ be a planar graph. Recall Euler's formula, which says that $|E| - |V| + |F| = 2$ where F is the set of faces. Counting with the formula gives:

$$\sum_{f \in F} (\deg(f) - 6) + \sum_{v \in V} (2 \deg(v) - 6) = -12 \quad (1)$$

By using the previous definition of the initial charges we get

$$\sum_{f \in F} ch(f) + \sum_{v \in V} ch(v) = -12. \quad (2)$$

□

The goal is to show that a counterexample has sum of all charges non-negative and hence it violates the Euler's formula. In Table 1 we observe that 3-, 4- and 5-faces have negative initial charge hence we need to deal with these negative charges. We satisfy 3-faces by the condition that our graph is triangle-free. Hence we have to deal only with 4- and 5-faces. Observe that forbidding C_3 , C_4 and C_5 is a sufficient condition for a planar graph to be 3-choosable.

4 Discharging 4-faces and 5-faces

We denote the graph consisting of two cycles sharing exactly one edge by $C_{x|y}$ where x and y are length of those two cycles. By $C_{x \bullet y}$ we denote two cycles which share exactly one vertex. We say that cycles are *touching* if they share exactly one vertex. We call two cycles *adjacent* if they share exactly one edge.

We already identified some reducible configurations consisting of C_4 in Lemma 1. The other configurations of 4-cycles can become a configuration of 4-faces and we need to show discharging rules to deal with them. We do not exhibit any reducible configurations of 5-cycles but we show discharging rules for all allowed configurations of 5-faces.

A vertex v of degree at least 4 is called *non-shared* if it is a part of only one 4-face with a negative charge and $ch(v) \geq 2$. We say that vertex v is *shared* if it is a part of at least two faces with negative charges.

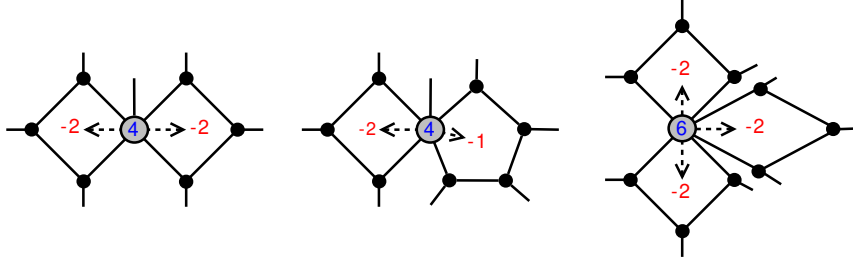

Figure 3: Rule 1. The grey vertices have a sufficient charge to eliminate the negative charges of the adjacent 4-faces and 5-faces.

Theorem 3. *Every planar graph without C_3 , $C_{4|4}$, $C_{4|5}$, $C_{5|5}$, and $C_{5|6}$ is 3-choosable.*

Proof. Assume for a contradiction that G' is a counterexample. Recall Lemma 1 about reducibility of configuration of 4-cycles and observation about reducibility of vertices degree smaller than three. Apply them on the graph G' . The resulting reduced graph G is still a counterexample since removing reducible configurations does not change planarity or 3-choosability. We assume that G is connected since we can consider every component separately.

We claim that there are no two 4-faces, 4-face and 5-face, two 5-faces or 5-face and 6-face that would share two edges because G does not contain any vertices of degree two or triangles; refer to Figure 7.

We claim that we are able to raise charge of all 4-faces and 5-faces in G to a non-negative value by using the following discharging rules.

The discharging rules:

1. transfer charge from a vertex v whose $\deg(v) \geq 5$ to all adjacent 4-faces and 5-faces; refer to Figure 3
2. on "cycle" of $C_{4\bullet 4}$ transfer charges from shared vertices to the $C_{4\bullet 4}$; refer to Figure 4
3. transfer charge from a non-shared vertex to its 4-face; refer to Figure 5
4. transfer charge from a vertex of degree 4 to both adjacent 5-faces; refer to Figure 6

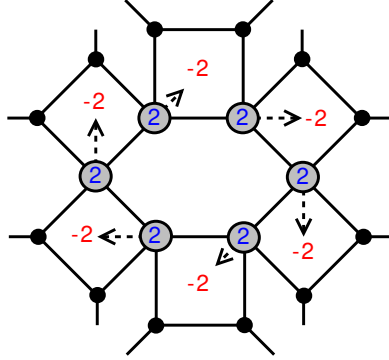

Figure 4: Rule 2. A cycle of 4-cycles and moving charges along the cycle.

5. transfer charge from a face of degree $d \geq 7$ to at most $\lfloor d/2 \rfloor$ adjacent 5-faces; refer to Figure 6

Observe that after applying any of these rules all 4-faces adjacent to vertices from which we took some charge have non-negative charge. The only case when there is no rule to raise charge of a 4-face is a reducible configuration from Lemma 1. Hence 4-faces are solved.

It is unclear whether the rules are sufficient to cover also all 5-faces. After applying rules 1-4 there are no two touching 5-faces with negative charges. We call the remaining 5-faces with negative charge *isolated*.

Assume that a k -face share some edges with isolated 5-faces. Note that the number of isolated 5-faces is at most $\lfloor k/2 \rfloor$ since the 5-faces share no vertices; refer to Figure 8.

Recall that the initial charge of any k -face is $k - 6$. We redistribute the charge from f to 5-faces and each 5-face receives at least $(k - 6) / \lfloor k/2 \rfloor$. The degree k of the face f is at least 7 since lower values are forbidden by the statement of the theorem. Thus each 5-face receives charge at least $1/3$; refer to Figure 8.

Every isolated 5-face is adjacent to five large faces which are sending charges at least $1/3$ to the 5-face. Hence the sum of all received charges by the 5-face is at least $5/3$. Recall that the initial charge of every 5-face is -1 . Thus the resulting charge of the 5-face is at least $2/3$.

Therefore after the discharging every face and every vertex will receive a nonnegative charge and we have a contradiction with Lemma 2. \square

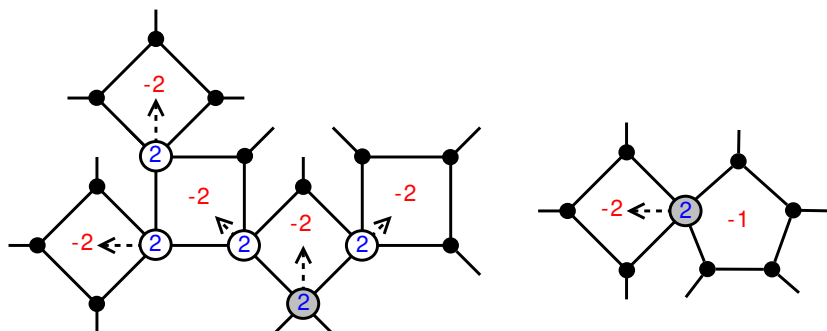

Figure 5: Rule 3. The grey vertex eliminate the negative charge of the adjacent 4-face. The other white shared vertices then become non-shared. Note that the negative charge of the 5-face is not discharged.

Observe that graph without C_6 does not contain $C_{4|4}$. We can also use absence of $C_{4|5}$ in graph without C_7 and absence of $C_{5|5}$ in graph without C_8 . Hence we can reformulate the result in the following way.

Corollary 4. *Every planar graph without C_3 , C_6 , C_7 and C_8 is 3-choosable.*

Corollary 5. *Every planar graph without C_3 , C_5 , and C_6 is 3-choosable.*

Corollary 6. *Every planar graph without C_3 , C_5 , and $C_{4|4}$ is 3-choosable.*

Acknowledgments

This research was done during DIMACS-DIMATIA REU 2006 at DIMACS. The support of KONTAKT grant ME 886 is greatly appreciated. Many useful comments by Jiří Fiala, Daniel Král' and Martin Tancer improved the whole work.

References

- [1] N. Alon and M. Tarsi. Colorings and orientations of graphs. *Combinatorica*, 12(2):125–134, 1992.

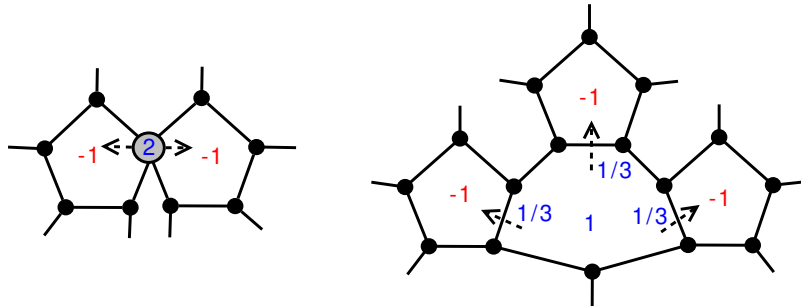

Figure 6: Rule 4 and rule 5. Discharging touching 5-faces and distributing charge 1 from a 7-face to surrounding 5-faces.

- [2] Paul Erdős, Arthur L. Rubin, and Herbert Taylor. Choosability in graphs. *Combinatorics, graph theory and computing, Proc. West Coast Conf., Arcata/Calif. 1979, 125-157 (1980).*, 1980.
- [3] Jan Kratochvíl and Zsolt Tuza. Algorithmic complexity of list colorings. *Discrete Appl. Math.*, 50(3):297–302, 1994.
- [4] Peter C.B. Lam, Wai Chee Shiu, and Zeng Min Song. The 3-choosability of plane graphs of girth 4. *Discrete Math.*, 294(3):297–301, 2005.
- [5] Carsten Thomassen. Every planar graph is 5-choosable. *J. Comb. Theory, Ser. B*, 62(1):180–181, 1994.
- [6] Carsten Thomassen. 3-list-coloring planar graphs of girth 5. *J. Comb. Theory, Ser. B*, 64(1):101–107, 1995.
- [7] V.G. Vizing. Vertex colorings with given colors (in Russian). *Metody Diskret. Analiz, Novosibirsk*, 29:3–10, 1976.
- [8] Margit Voigt. List colourings of planar graphs. *Discrete Math.*, 120(1-3):215–219, 1993.
- [9] Margit Voigt. A not 3-choosable planar graph without 3-cycles. *Discrete Math.*, 146(1-3):325–328, 1995.

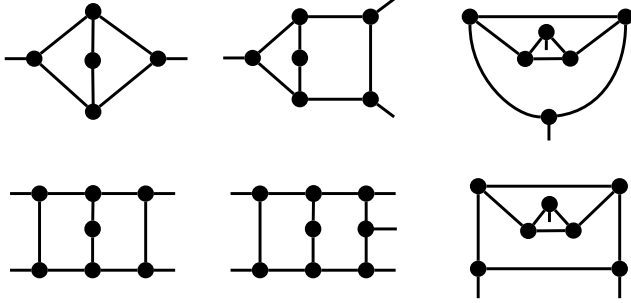

Figure 7: Two small cycles drawn as a faces that share two edges require a vertex of degree two or triangles.

- [10] Haihui Zhang. On 3-choosability of plane graphs without 5-, 8- and 9-cycles. *J. Lanzhou Univ., Nat. Sci.*, 41(3):93–97, 2005.
- [11] Haihui Zhang and Baogang Xu. On 3-choosability of plane graphs without 6-, 7- and 9-cycles. *Appl. Math., Ser. B (Engl. Ed.)*, 19(1):109–115, 2004.

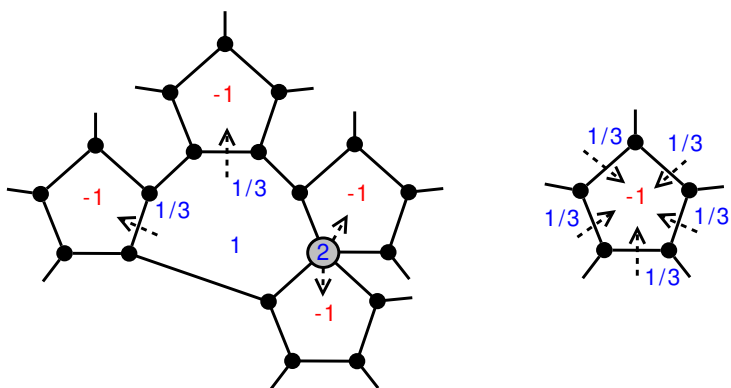

Figure 8: A big face is sending charges only to isolated 5-faces and incoming charges to an isolated 5-face.